



Storage Bins



Features

- Application storage • capacity from 242 lbs (110 kg) to 1807 lbs (821 kg)
- Ultra-low profile - 28 inches (711 mm) to 66 inches (1676 mm) tall
- Multiple bin tops provide an easy solution for mounting Icemakers on different sized bins
- Each polyethylene bin liner is insulated with foam for maximum ice preservation - 1.5 To 3 inches of insulation
- Safe-Hold Hinge reduces risk of door closing accidentally
- Perfect-fit seal for improved ice preservation
- Rugged, fingerprint-proof door
- Built-in ice scoop holders
- Sturdy leg design - 6 inch adjustable NSF approved legs - standard
- Stainless exterior
- Corrosion-proof bin liner

Machine Type and Width	B25 255 lbs (116 kg) 30 in. (762mm)	B40 365 lbs (166 kg) 30 in. (762mm)	B42 374 lbs (170 kg) 22 in. (559mm)	B55 556 lbs (252 kg) 30 in. (762mm)	B100 927 lbs (420 kg) 48 in. (1219mm)	B120 1193 lbs (541 kg) 48 in. (1219mm)	B150 1499 lbs (680 kg) 60 in. (1524mm)	B170 1866 lbs (846 kg) 60 in. (1524mm)
22" Wide ICE Series [®] Cube Icemakers	KBT 19	KBT 19	Kit not required	KBT 19	N/A	N/A	N/A	N/A
30" Wide ICE Series [®] Cube Icemakers	Kit not required	Kit not required	N/A	Kit not required	KBT 5	Filler Kit Required	Kit not required	Kit not required
48" Wide ICE Series [®] Cube Icemakers	N/A	N/A	N/A	N/A	Kit not required	Kit not required	Kit not required	Kit not required
16" Wide Flake Icemakers	KBT 8	KBT 8	KBT 14	KBT 8	KBT 7	KBT 41**	KBT 61**	KBT 61**
16" Wide Flake Icemakers (2)	N/A	N/A	N/A	N/A	KBT 9	KBT 42**	KBT 62**	KBT 62**
48" Wide Flake Icemakers	N/A	N/A	N/A	N/A	Kit not required	Kit not required	Kit not required	Kit not required
21" Wide Pearl Icemakers	KBT19	KBT19	KBT24	KBT19	KBT23	KBT23	N/A	N/A
21" Wide Pearl Icemakers (2)	N/A	N/A	N/A	N/A	KBT22	KBT22	N/A	N/A
30" Wide Pearl Icemakers	Kit not required	Kit not required	N/A	Kit not required	KBT23	N/A	N/A	N/A
42" Wide Pearl Icemakers	N/A	N/A	N/A	N/A	KBT26	KBT26	N/A	N/A



11100 E. 45th Avenue
Denver, CO 80239

Phone: 303.371.3737
Fax: 303.371.6296
www.iceomatic.com

Rev: A-05/08
Part: 7001

Enodis

Storage Bins

Dimensions

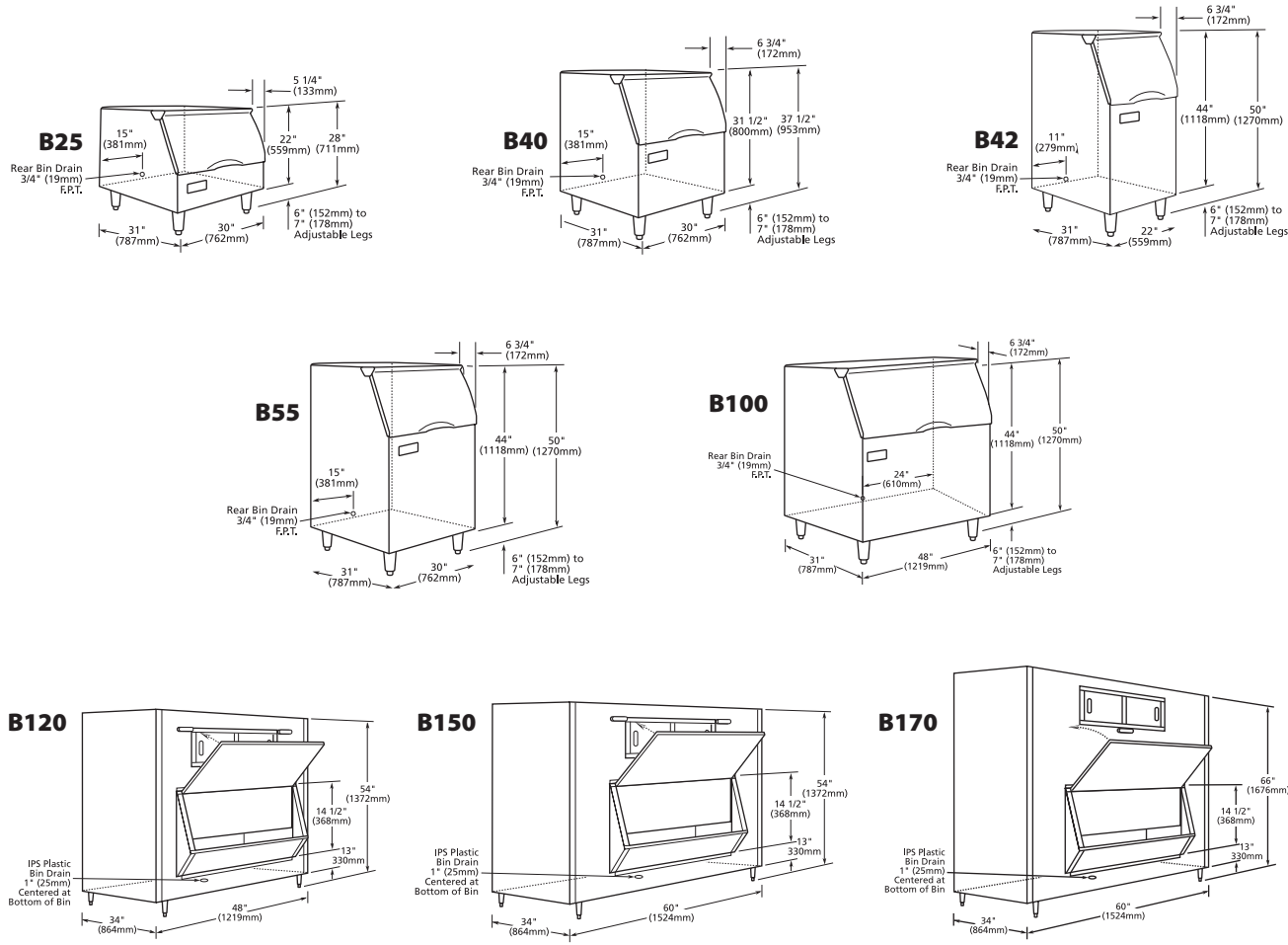

Bin Tops

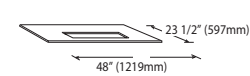

KBT5
Bin Top for 48" (1219mm) bins with 30" (762mm) ICE Series Cube ICE Makers

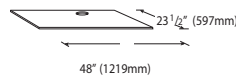

KBT7
Bin Top for 48" (1219mm) bins with (1) 16" (406mm) EMF Flake ICE Makers

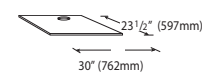

KBT8
Bin Top for 30" (762mm) bins with (1) 16" (406mm) EMF Flake ICE Makers

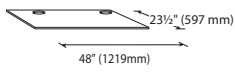

KBT9
Bin Top for 48" (1219mm) bins with (2) 16" (406mm) EMF Flake ICE Makers

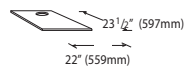

KBT14
Bin Top for the 22" (559mm) bin with (1) 16" (406mm) EMF Flake ICE Makers

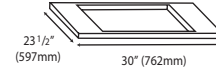

KBT19
Bin Top for 30" (762mm) bins with 22" (559mm) ICE Series Cube ICE Makers