



Foodservice Equipment

Job _____ Item# _____

Manual Gas Griddles
TMGM24, TMGM36, TMGM48
Gas Griddles with Thermostatic Controls
TMGT24, TMGT36, TMGT48

Standard Features:

- NEW Ultra smooth 3/4" thick polished steel plate.
- Manual griddle designed with 1/4 turn manual control and standing pilot.
- Thermostat griddles feature throttling thermostat that adjust from 150°- 450°F.
- Available in 24", 36" and 48" widths.
- High performance 20,000 BTU aluminized steel "U" shape burner every 12".
- Spatula wide 3-1/4" front grease trough and grease chute.
- Stainless steel front panel, bull nose and grease drawer.
- 3/4" rear gas connection and universal pressure regulator supplied. Field convertible to LP with orifices included.
- 4" nickel plated steel legs.



TMGM36

Applications:

The Toastmaster Countertop Gas Griddles are the most economical and flexible Countertop Griddles in the food service industry. They offer unsurpassed performance, combining a proven control system with Toastmaster quality and durability. Available in three different widths - 24", 36" and 48".

General Information:

Stainless steel front including top rail, with aluminized steel rear and sides, with 4-3/8" high rear and side splash guards and full width stainless steel grease trough and easy to access grease drawer.

Gas units have 5/8" polished rolled steel plate.

Warranty

Toastmaster griddles are covered by Toastmaster's one year parts and labor warranty.



Manual Gas Griddles

TMGM24, TMGM36, TMGM48

Gas Griddles with Thermostatic Controls

TMGT24, TMGT36, TMGT48

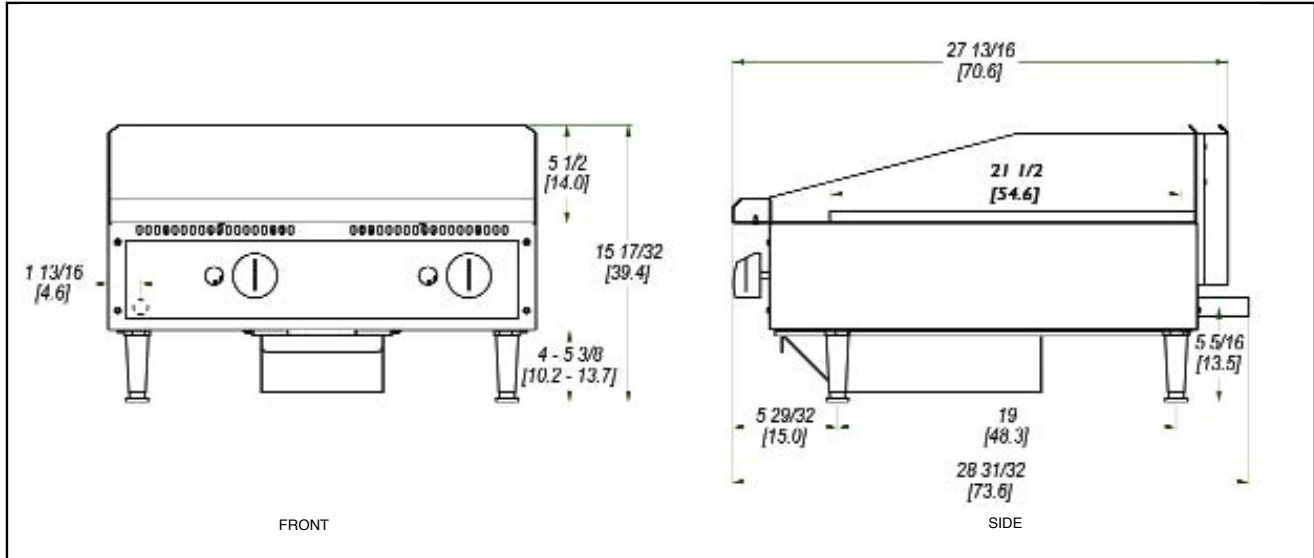

Model Number	TMGM24	TMGM36	TMGM48	TMGT24	TMGT36	TMGT48
Dimensions	24" W x 15-17/32" H x 27-13/16" L	36" W x 15-17/32" H x 27-13/16" L	48" W x 15-17/32" H x 27-13/16" L	24" W x 15-17/32" H x 27-13/16" L	36" W x 15-17/32" H x 27-13/16" L	48" W x 15-17/32" H x 27-13/16" L
Number of Controls	2	3	4	2	3	4
BTU	40,000	60,000	80,000	40,000	60,000	80,000
Griddle Plate Thickness	3/4"	3/4"	3/4"	3/4"	3/4"	3/4"
Cook Zone Size	24"	36"	48"	24"	36"	48"
Installed Weight (lbs.) (kg)	148 lbs. (67.3)	221 lbs. (100.5)	295 lbs. (134.1)	148 lbs. (67.3)	221 lbs. (100.5)	295 lbs. (134.1)
Shipping Weight (lbs.) (kg)	158 lbs. (71.8)	236 lbs. (107.3)	315 lbs. (143.2)	158 lbs. (71.8)	236 lbs. (107.3)	315 lbs. (143.2)

Typical Specifications:

Gas griddles are constructed with a stainless steel front panel and reinforced wall aluminized steel side panels. Griddle plate is 3/4" (1.9 cm) thick steel plate with 4-3/8" (11.1 cm) high tapered wrap-around stainless steel splash guard. Unit has 3-1/4" (8.3 cm) wide front grease trough with grease chute and a 4-1/2 qt. (4.257 L) stainless steel grease drawer. Unit is equipped with a 20,000 BTU aluminized steel burner for every 12" (30.5 cm) of width and is controlled by either a manual control valve or throttling thermostat. Valve knobs are protected by a stainless steel bull nose front. A standing pilot is provided. Griddles are supplied with 4" (10.2 cm) high die cast nickel-plated legs with a 1-3/8" (3.5 cm) adjustment. Gas connection is a 3/4" (1.3 cm) N.P.T. male with a convertible pressure regulator. Units are approved for installation within 6" (15.2 cm) of combustible and non-combustible surfaces and are UL Gas Certified and UL Sanitation listed. Printed in the U.S.A.

INTENDED FOR COMMERCIAL USE ONLY. NOT FOR HOUSEHOLD USE.

TM108/1103



Toastmaster, in line with its policy to continually improve its product, reserves the right to change materials or specifications without notice. Such revisions do not entitle the buyer to corresponding changes, improvements, additions, or replacements for previously purchased equipment.



Toastmaster® 10 Sunnen Dr, St. Louis MO 63143 • www.toastmastercorp.com
Telephone: 1-314-678-6347 • Fax: 1-314-781-3636